

Article number: 12308100080110
Description: KLEE-coil 308 100 080.110
M8 Hardened/zinc-plated Blue

Measures

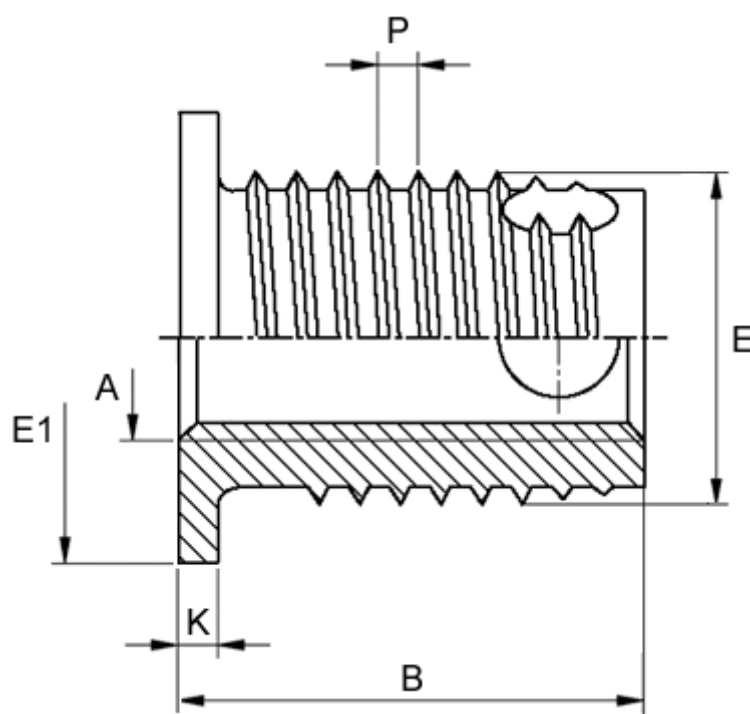

Female thread A	= M8
Flange diameter E1	= 15
Flange height	= 1.5
Length B	= 15.5
Male thread E	= 12
Min hole depth blind hole	= 17
Thread pitch P	= 1.50
Type	= 308 100 080 ...